

EDCON-COMPONENTS



Technical Discription

Type;	Screw-Type
Insulation Resistance:	10m Ω Min 500VDC
Contact Resistance:	5mΩ @ 1A DC
Dielectric Strength:	AC 3000V for min. 60Sec.
Rated Current:	10A
Rated Voltage:	250VAC
Fuse Type/Size:	5x20mm
Protection Degree:	IP40

Drawing (mm)

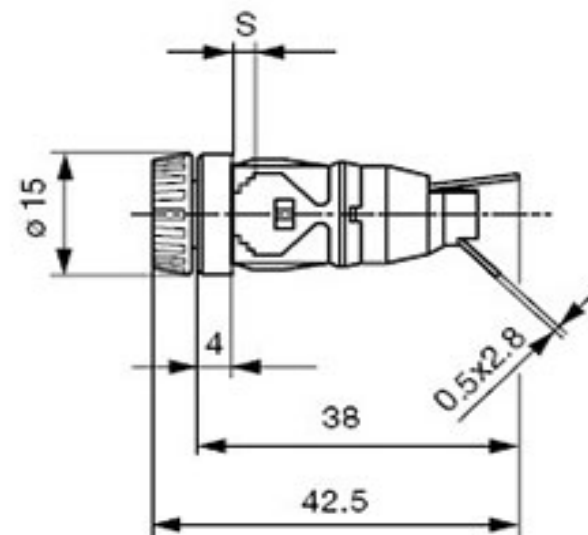

Approvals



Panel Hole (mm)

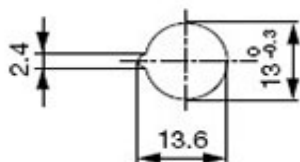

Front Panel Fuse Holder

Part No.: **R54109**

DRW:	Jason	CHKD	Wilson	MATL:	Wilson	TOLERANCE	Mason	DATE	24.05.2014	Customer:
APPD:	Schumi			FINISH	Jamy		Sheet No.	1 from 2		

EDCON-COMPONENTS



Ordering Informations

Serie	Spezial Function	special function	ROHS	Packing						
-------	------------------	------------------	------	---------	--	--	--	--	--	--

R54109	A	0	R	BU						
---------------	----------	----------	----------	-----------	--	--	--	--	--	--

A= 5x20mm Fuse	0= No function	R= ROHS Conform	BU= Bulk-Ware

Front Panel Fuse Holder

Part No.: **R54109**

DRW:	Jason	CHKD	Wilson	MATL:	Wilson	TOLERANCE	Mason	DATE	24.05.2014
APPD:	Schumi			FINISH	Jamy		Sheet No.	2 from 2	Customer: